

Instructions For Use

SW 32 Ti and SW 32.1 Ti Swinging-Bucket Rotors

For Use in Beckman Coulter
Class H, R, and S
Preparative Ultracentrifuges



LXL-TB-015BD
February 2014



Beckman Coulter, Inc.
250 S. Kraemer Blvd.
Brea, CA 92821 U.S.A.



SW 32 Ti and SW 32.1 Ti Swinging-Bucket Rotors
LXL-TB-015BD (February 2014)

© 2013–2014 Beckman Coulter, Inc.
All rights reserved.

All rights reserved. No part of this document may be reproduced or transmitted in any form or by any means, electronic, mechanical, photocopying, recording, or otherwise, without prior written permission from Beckman Coulter, Inc.

Beckman Coulter, Quick-Seal and the stylized logo are trademarks of Beckman Coulter, Inc. and are registered in the USPTO.

All other trademarks, service marks, products, or services are trademarks or registered trademarks of their respective holders.

Find us on the World Wide Web at:
www.beckmancoulter.com

Printed in U.S.A.

Safety Notice

Read all product manuals and consult with Beckman Coulter-trained personnel before attempting to use this equipment. Do not attempt to perform any procedure before carefully reading all instructions. Always follow product labeling and manufacturer's recommendations. If in doubt as to how to proceed in any situation, contact your Beckman Coulter Representative.



This safety notice summarizes information basic to the safe use of the rotors described in this manual. The international symbol displayed to the left is a reminder to the user that all safety instructions should be read and understood before operation or maintenance of this equipment is attempted. When you see the symbol on other pages of this publication, pay special attention to the safety information presented. Observance of safety precautions will also help to avoid actions that could damage or adversely affect the performance of the rotor. These rotors were developed, manufactured, and tested for safety and reliability as part of a Beckman Coulter ultracentrifuge/rotor system. Their safety or reliability cannot be assured if used in an ultracentrifuge not of Beckman Coulter's manufacture or in a Beckman Coulter ultracentrifuge that has been modified without Beckman Coulter's approval.

Alerts for Danger, Warning, Caution, and Note

DANGER

DANGER indicates an imminently hazardous situation which, if not avoided, will result in death or serious injury.

WARNING

WARNING indicates a potentially hazardous situation which, if not avoided, could result in death or serious injury.

CAUTION

CAUTION indicates a potentially hazardous situation, which, if not avoided, may result in minor or moderate injury. It may also be used to alert against unsafe practices.

NOTE NOTE is used to call attention to notable information that should be followed during installation, use, or servicing of this equipment.

Safety Information for the SW 32 Ti and SW 32.1 Ti Rotors

Handle body fluids with care because they can transmit disease. No known test offers complete assurance that such fluids are free of micro-organisms. Some of the most virulent—Hepatitis (B and C) viruses, HIV (I–V), atypical mycobacteria, and certain systemic fungi—further emphasize the need for aerosol protection. Handle other infectious samples according to good laboratory

Safety Notice

Safety Information for the SW 32 Ti and SW 32.1 Ti Rotors

procedures and methods to prevent spread of disease. Because spills may generate aerosols, observe proper safety precautions for aerosol containment. Do not run toxic, pathogenic, or radioactive materials in these rotors without taking appropriate safety precautions. Biosafe containment should be used when Risk Group II materials (as identified in the World Health Organization *Laboratory Biosafety Manual*) are handled; materials of a higher group require more than one level of protection.

The rotors and accessories are not designed for use with materials capable of developing flammable or explosive vapors. Do not centrifuge such materials in nor handle or store them near the centrifuge

Although rotor components and accessories made by other manufacturers may fit in the SW 32 Ti and SW 32.1 Ti rotors, their safety in these rotors cannot be ascertained by Beckman Coulter. Use of other manufacturers' components or accessories in these rotors may void the rotor warranty and should be prohibited by your laboratory safety officer. Only the components and accessories listed in this publication should be used in this rotor.

Attach all six buckets, loaded or empty, to the rotor for every run. Make sure that filled containers are loaded symmetrically into the rotor and that opposing tubes are filled to the same level with liquid of the same density. Make sure that buckets containing Quick-Seal tubes have the proper floating spacers inserted (if applicable) before installing the bucket cap.

If disassembly reveals evidence of leakage, you should assume that some fluid escaped the rotor. Apply appropriate decontamination procedures to the centrifuge and accessories.

Never exceed the maximum rated speed of the rotor and labware in use. Refer to the section on [Run Speeds](#), and derate the run speed as appropriate.

Do not use sharp tools on the rotor that could cause scratches in the rotor surface. Corrosion begins in scratches and may open fissures in the rotor with continued use.

Contents



Safety Notice, iii

Alerts for Danger, Warning, Caution, and Note, iii

Safety Information for the SW 32 Ti and SW 32.1 Ti Rotors, iii

SW 32 Ti and SW 32.1 Ti Swinging-Bucket Rotors, 1

Specifications for the SW 32 Ti Rotor, 1

Specifications for the SW 32.1 Ti Rotor, 2

Description, 3

Preparation and Use, 4

Prerun Safety Checks, 4

Rotor Preparation, 5

Operation, 7

Removal and Sample Recovery, 7

Tubes and Accessories, 8

Temperature Limits, 10

OptiSeal Tubes, 11

Quick Seal Tubes, 11

konical Tubes, 12

Polypropylene and Ultra-Clear Open-Top Tubes, 12

Run Times, 13

Run Speeds, 14

Selecting CsCl Gradients, 20

Adjusting Fill Volumes, 20

Typical Examples for Determining CsCl Run Parameters, 21

Care and Maintenance, 22

Maintenance, 22

Cleaning, 23

Decontamination, 24

Sterilization and Disinfection, 24

Storage, 24

Returning a Rotor, 25

Supply List, 25

Replacement Rotor Parts, 25

Other, 26

Illustrations

- 1 Arranging Tubes Symmetrically in the Rotor Buckets, 6
- 2 Precipitation Curves for the SW 32 Ti Rotor, 16
- 3 CsCl Gradients at Equilibrium for the SW 32 Ti Rotor, 17
- 4 Precipitation Curves for the SW 32.1 Ti Rotor, 18
- 5 CsCl Gradients at Equilibrium for the SW 32.1 Ti, 19

Tables

1	Beckman Coulter Tubes and Accessories for the SW 32 Ti Rotor, 8
2	Beckman Coulter Tubes and Accessories for the SW 32.1 Ti Rotor, 9
3	Relative Centrifugal Fields for the SW 32 Ti and SW 32.1 Ti Rotors, 15

SW 32 Ti and SW 32.1 Ti Swinging-Bucket Rotors

Specifications for the SW 32 Ti Rotor

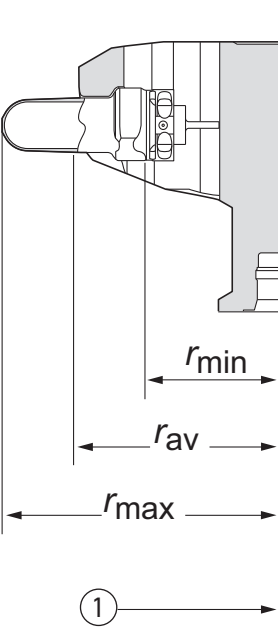
 <p>1. Axis of Rotation</p>	Maximum speed	32,000 RPM
	Density rating at maximum speed	1.2 g/mL
	Relative Centrifugal Field ^a at maximum speed	
	At r_{\max} (152.5 mm)	$175,000 \times g$
	At r_{av} (109.7 mm)	$126,000 \times g$
	At r_{\min} (66.8 mm)	$76,600 \times g$
	k factor at maximum speed	204
	k factor at maximum speed (5 to 20% sucrose gradient; 5°C)	
	When particle density = 1.3 g/mL	468
	When particle density = 1.5 g/mL	428
	When particle density = 1.7 g/mL	412
	Conditions requiring speed reductions	see Run Speeds
	Number of buckets	6
	Available tubes	see Table 1
	Nominal tube dimensions (largest tube)	25 × 89 mm
	Nominal tube capacity (largest tube)	38.5 mL
	Nominal rotor capacity	231 mL
Approximate acceleration time to maximum speed (rotor fully loaded)	6 ³ / ₄ min	
Approximate deceleration time from maximum speed (rotor fully loaded)	9 ¹ / ₂ min	
Weight of fully loaded rotor	8.5 kg (18.7 lb)	
Rotor and bucket material	titanium	

a. Relative Centrifugal Field (RCF) is the ratio of the centrifugal acceleration at a specified radius and speed (rw^2) to the standard acceleration of gravity (g) according to the following formula: $RCF = \omega^2 r / g$ — where r is the radius in millimeters, ω is the angular velocity in radians per second ($2 \pi \text{ RPM} / 60$), and g is the standard acceleration of gravity (9807 mm/s^2). After substitution: $RCF = 1.12r (\text{RPM}/1000)^2$

Specifications for the SW 32.1 Ti Rotor

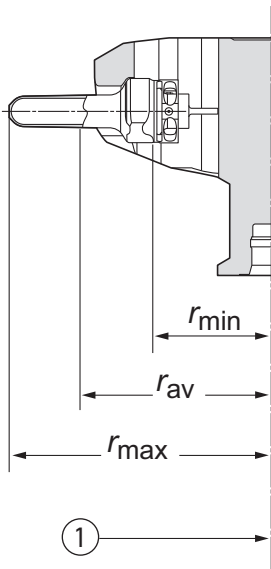

1. Axis of Rotation

Maximum speed	32,000 RPM
Density rating at maximum speed	1.2 g/mL
Relative Centrifugal Field ^a at maximum speed	
At r_{max} (162.8 mm)	$187,000 \times g$
At r_{av} (113.6 mm)	$130,000 \times g$
At r_{min} (64.4 mm)	$73,900 \times g$
k factor at maximum speed	229
k factor at maximum speed (5 to 20% sucrose gradient; 5°C)	
When particle density = 1.3 g/mL	613
When particle density = 1.5 g/mL	560
When particle density = 1.7 g/mL	536
Conditions requiring speed reductions	see Run Speeds
Number of buckets	6
Available tubes	see Table 2
Nominal tube dimensions (largest tube)	16 × 102 mm
Nominal tube capacity (largest tube)	17 mL
Nominal rotor capacity	102 mL
Approximate acceleration time to maximum speed (rotor fully loaded)	6 1/2 min
Approximate deceleration time from maximum speed (rotor fully loaded)	9 1/4 min
Weight of fully loaded rotor	8.3 kg (18.3 lb)
Rotor and bucket material	titanium

a. Relative Centrifugal Field (RCF) is the ratio of the centrifugal acceleration at a specified radius and speed ($r\omega^2$) to the standard acceleration of gravity (g) according to the following formula: $RCF = r\omega^2/g$ — where r is the radius in millimeters, ω is the angular velocity in radians per second ($2\pi \text{ RPM}/60$), and g is the standard acceleration of gravity (9807 mm/s^2). After substitution: $RCF = 1.12r(\text{RPM}/1000)^2$

Description

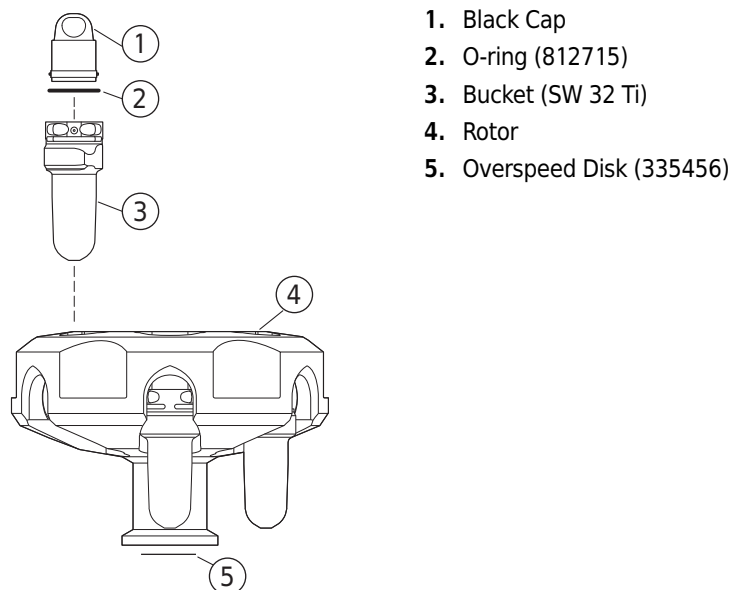

These Beckman Coulter rotors have been manufactured in an ISO 9001 or 13485 facility for use with the specified Beckman Coulter ultracentrifuges.

The SW 32 Ti and SW 32.1 Ti are swinging bucket rotors designed to centrifuge up to six tubes each. Used in Beckman Coulter class H, R, and S preparative ultracentrifuges, these rotors develop centrifugal forces for the separation of subcellular particles and viruses in density gradients. The rotors have a common rotor body with buckets that can be used interchangeably (see [Rotor Preparation](#)). Bucket and rotor body positions are numbered for operator convenience.

The rotor body and buckets are made of titanium, finished with polyurethane paint. Bucket caps are made of aluminum, anodized for corrosion resistance. Each bucket and cap assembly sets into grooves in the rotor body. O-rings, made of Buna N rubber, between each bucket and bucket cap maintain atmospheric pressure inside the buckets during centrifugation.

For overspeed protection, a Beckman Coulter ultracentrifuge equipped with a photoelectric detector will monitor the overspeed disk on the rotor bottom and shut down the run if a speed exceeding the maximum allowable run speed is detected.

See the Warranty at the back of this manual for warranty information.

Preparation and Use

Specific information about the SW 32 Ti and SW 32.1 Ti rotors is given here. Information common to these and other rotors is contained in *Rotors and Tubes for Preparative Ultracentrifuges* (publication LR-IM), which should be used together with this manual for complete rotor and accessory operation. Publication LR-IM is included in the literature package with this rotor manual.

NOTE Although rotor components and accessories made by other manufacturers may fit in the SW 32 Ti and SW 32.1 Ti rotors, their safety in these rotors cannot be ascertained by Beckman Coulter. Use of other manufacturers' components or accessories in these rotors may void the rotor warranty and should be prohibited by your laboratory safety officer. Only the components and accessories listed in this publication should be used in these rotors.

Prerun Safety Checks



Read the [Safety Notice](#) section at the front of this manual before using the rotor.

- 1 Make sure that the rotor, buckets, and caps are clean and show no signs of corrosion or cracking.

- 2 Make sure that the rotor is equipped with the correct overspeed disk.
 - a. If the disk is missing or damaged, replace it according to the instructions in *Rotors and Tubes*.



- 3 Verify that the tubes and bottles being used are listed in [Table 1](#) or [Table 2](#).

 - 4 Check the chemical compatibilities of all materials used.
 - Refer to *Chemical Resistances* (publication IN-175), included in the *Rotors and Tubes* CD.
-

Rotor Preparation

For runs at other than room temperature refrigerate or warm the rotor beforehand for fast equilibration.

NOTE Place the rotor on the rotor stand (332400) when it is not in the centrifuge. Take care to protect the overspeed disk from damage when handling the rotor.

- 1 Install the rotor body on the drive hub.
 - a. Slowly turn the rotor to the right (clockwise) to make sure it is properly seated.
- 2 Load the filled containers into the buckets (see page 8 for tube and accessory information).
 - a. Complete loading by placing the correct floating spacers (if required) over the tubes.
- 3 Ensure that bucket gaskets are lightly but evenly coated with silicone vacuum grease.
 - a. Do not run a bucket without an O-ring, as the bucket will leak.

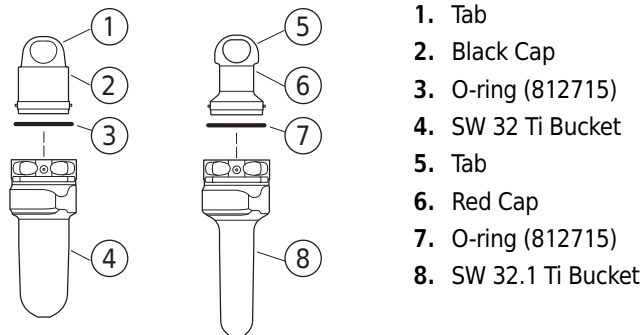

CAUTION
Use only black caps (369643) on black SW 32 Ti buckets and red caps (369645) on red SW 32.1 Ti buckets.

- 4 Use a lint-free cotton swab to apply Spinkote lubricant (396812) to cap grooves in the bucket tops.
 - a. Match bucket caps with numbered buckets.
 - b. Align the pins on each side of the cap with the guide slots in the bucket.
 - c. Twist the cap clockwise until it stops (one-quarter turn).

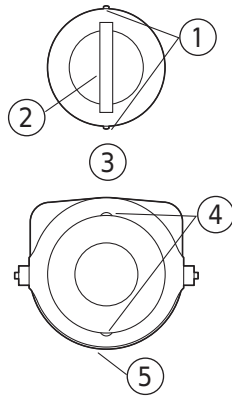

1. Cap Pins
2. Tab
3. Bucket Top View
4. Guide Slots
5. This side toward outside of rotor

- 5 Grasp the bucket cap tabs and lower the buckets into the openings on the rotor body with the rounded sides toward the outside of the rotor.

NOTE A bucket will not seat in the rotor if it is inserted in the rotor with the rounded side toward the rotor center. The bucket will fall through, spilling or disturbing the tube contents.

Six bucket assemblies must be installed, whether loaded or empty. If fewer than six tubes are being run, they must be arranged symmetrically in the rotor (see Figure 1). Opposing tubes must be filled to the same level with liquid of the same density.

Figure 1 Arranging Tubes Symmetrically in the Rotor Buckets

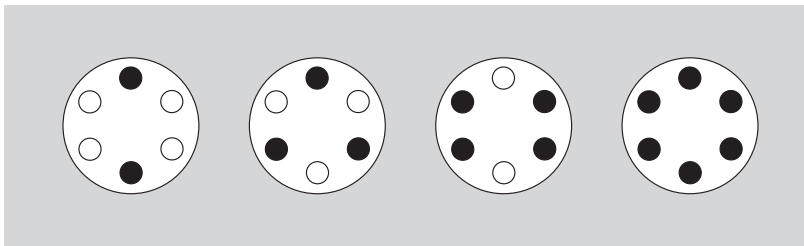

NOTE Two, three, four, or six tubes can be centrifuged per run if they are arranged in the rotor as shown. All bucket assemblies must be attached to the rotor, whether loaded or empty.

Operation

For low-temperature runs, precool the rotor in the centrifuge or in a refrigerator before use—especially before short runs—to ensure that the rotor reaches the set temperature. A suggested precooling cycle is a minimum of 30 minutes at 2000 RPM at the required temperature.

- 1 Refer to the centrifuge instruction manual for additional operating instructions.
- 2 For additional operating information, see the following:
 - [Run Times](#), page 13, for using k factors to adjust run durations.
 - [Run Speeds](#), page 14, for information about speed limitations.
 - [Selecting CsCl Gradients](#), page 20, for methods to avoid CsCl precipitation during centrifugation.

Removal and Sample Recovery

CAUTION

If disassembly reveals evidence of leakage, you should assume that some fluid escaped the rotor. Apply appropriate decontamination procedures to the centrifuge and accessories.

- 1 Grasp the bucket cap tabs and lift up to remove the buckets.
 - (Buckets may be removed without removing the rotor body from the ultracentrifuge.)
- 2 Remove the bucket caps by twisting counterclockwise and lifting up.
 - a. Use a tube removal tool (361668) or hemostat to remove the spacers and tubes.

NOTE If the conical-shaped adapters that support konical tubes are difficult to remove after centrifugation, an extractor tool (354468) is available to facilitate removal.

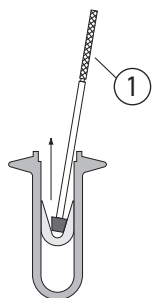

1. Extractor Tool (354468)
While pressing the rubber tip against the adapter wall, pull the tube and adapter up and out of the cavity.

- 3 To remove the rotor from the centrifuge, lift the rotor straight up and off the drive hub.
 - a. Set the rotor on the rotor stand.

Tubes and Accessories

The SW 32 Ti rotor uses tubes and accessories listed in [Table 1](#); the SW 32.1 Ti rotor uses tubes and accessories listed in [Table 2](#). Be sure to use only those items listed, and to observe the maximum speed limits shown. Refer to Appendix A in *Rotors and Tubes* for information on the chemical resistances of tube and accessory materials.

Table 1 Beckman Coulter Tubes and Accessories for the SW 32 Ti Rotor^a

Tube			Required Accessory		Max Speed/ RCF/ k factor
Dimensions/ Nominal Volume/	Description	Part Number	Description	Part Number	
25 × 89 mm 38.5 mL	Ultra Clear open-top	344058 (pkg/50)	none	—	32,000 RPM 175,000 × g 204
25 × 89 mm 38.5 mL	polypropylene open-top	326823 (pkg/50)	none	—	32,000 RPM 175,000 × g 204
25 × 89 mm 31 mL	thickwall polypropylene open-top	355642 (pkg/25)	none	—	32,000 RPM 175,000 × g 198
25 × 89 mm 31 mL	thickwall polycarbonate open-top	355631 (pkg/25)	none	—	32,000 RPM 175,000 × g 202
25 × 83 mm 33.5 mL	polypropylene Quick-Seal, bell-top	344623 (pkg/50)	Noryl ^b floating spacer	355536	32,000 RPM 175,000 × g 192
25 × 89 mm 31.5 mL	konical polypropylene open-top	358126 (pkg/50)	Hytrel ^c adapter	358156 (pkg/6)	32,000 RPM 175,000 × g 199
25 × 83 mm 28 mL	konical polypropylene Quick-Seal, bell-top	358651 (pkg/50)	adapter	358156	32,000 RPM 175,000 × g 198
			Noryl floating spacer	355536	
25 × 76 mm 25.5 mL	konical polypropylene open-top	358125 (pkg/50)	Hytrel adapter	358156 (pkg/6)	32,000 RPM 175,000 × g 156

Table 1 Beckman Coulter Tubes and Accessories for the SW 32 Ti Rotor^a (Continued)

Tube			Required Accessory		Max Speed/ RCF/ k factor
Dimensions/ Nominal Volume/	Description	Part Number	Description	Part Number	
25 × 64 mm 27 mL	polypropylene Quick-Seal, bell-top	343665 (pkg/50)	Noryl floating spacer	355536	32,000 RPM 175,000 × g 146
26 × 77 mm 32.4 mL	OptiSeal bell-top ^d	361625 (pkg/50)	Ultem spacer ^b	392833	32,000 RPM 175,000 × g 155
25 × 38 mm 15 mL	polypropylene Quick-Seal, bell-top	343664 (pkg/50)	Noryl floating spacer	355536	32,000 RPM 175,000 × g 81
25 × 38 mm 8.4 mL	konical polypropylene Quick-Seal, bell-top	358652 (pkg/50)	Hytrek adapter	358156 (pkg/6)	32,000 RPM 175,000 × g 74
			Noryl floating spacer	355536	
25 × 76 mm 22.5 mL	konical polypropylene Quick-Seal, bell-top	358654 (pkg/50)	Hytrek adapter	358156	32,000 RPM 175,000 × g 155
			Noryl floating spacer	355536	

- a. Use only the items listed here..
- b. Noryl and Ultem are registered trademarks of GE Plastics.
- c. Hytrek is a registered trademark of E.I. Du Pont de Nemours and Company.
- d. Includes disposable plastic plugs.

Table 2 Beckman Coulter Tubes and Accessories for the SW 32.1 Ti Rotor^a

Tube			Required Accessory		Max Speed/ RCF/ k factor
Dimensions/ Nominal Volume/	Description	Part Number	Description	Part Number	
16 × 102 mm 14.5 mL	polypropylene Quick-Seal, bell-top	356291 (pkg/50)	Noryl floating spacer	355579	32,000 RPM 187,000 × g 199
16 × 102 mm 17 mL	Ultra-Clear, open-top	344061 (pkg/50)	none	—	32,000 RPM 187,000 × g 228

Table 2 Beckman Coulter Tubes and Accessories for the SW 32.1 Ti Rotor^a (Continued)

Tube			Required Accessory		Max Speed/ RCF/ k factor
Dimensions/ Nominal Volume/	Description	Part Number	Description	Part Number	
16 × 102 mm 12.5 mL	konical polypropylene Quick-Seal bell-top	358653 (pkg/50)	adapter	358155	32,000 RPM 187,000 × g 205
			Noryl floating spacer	355579	
16 × 96 mm 16.5 mL	polypropylene, open-top	337986 (pkg/50)	none	—	32,000 RPM 187,000 × g 228
16 × 93 mm 13.5 mL	konical polypropylene open-top	358123 (pkg/50)	Hytrel adapter	358155	32,000 RPM 187,000 × g 225
16 × 67 mm 10.5 mL	polypropylene Quick-Seal, bell-top	344622 (pkg/50)	Noryl floating spacer	355579	32,000 RPM 187,000 × g 133
16 × 57 mm 8 mL	polypropylene Quick-Seal, bell-top	344621 (pkg/50)	Noryl floating spacer	355579	32,000 RPM 187,000 × g 102
16 × 44 mm 6.5 mL	polypropylene Quick-Seal, bell-top	345830 (pkg/50)	Noryl floating spacer	355579	32,000 RPM 187,000 × g 79
16 × 32 mm 4.5 mL	polypropylene Quick-Seal, bell-top	356562 (pkg/50)	Noryl floating spacer	355579	32,000 RPM 187,000 × g 56

a. Use only the items listed here..

Temperature Limits

- Plastic tubes have been centrifuge tested for use at temperatures between 4 and 25°C. For centrifugation at other temperatures, pretest tubes under anticipated run conditions.
- If plastic containers are frozen before use, make sure that they are thawed to at least 4°C prior to centrifugation.



OptiSeal Tubes

OptiSeal tubes come with plastic plugs and can be quickly and easily prepared for use. With the tube spacer in place, the g force during centrifugation ensures a tight, reliable seal that protects your samples.

- 1 Place the tubes in the rack and fill each tube to the base of the stem, leaving no fluid in the stem.
 - Overfilling the tube can cause spillage when the plug is inserted or can compromise seal integrity.
 - However, too much air can cause excessive tube deformation, disrupting gradients and sample bands.

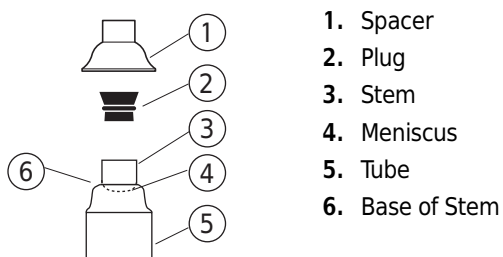

- 2 Refer to *Using OptiSeal Tubes* (publication IN-189), included in each box of tubes, for detailed information on the use and care of OptiSeal tubes.

Quick Seal Tubes

Quick-Seal tubes must be sealed prior to centrifugation. These tubes are heat sealed and do not need caps; however, spacers are required on top of the tubes when they are loaded into the rotor buckets.

- 1 Fill Quick-Seal tubes leaving a *small* bubble of air at the base of the neck.
 - a. Do not leave a large air space—too much air can cause excessive tube deformation.

- 2 Some of the tubes listed in [Table 1](#) and [Table 2](#) are part of the *g*-Max system, which uses a combination of small bell-top Quick-Seal tubes and floating spacers (also called *g*-Max spacers).
- This means that you can run the shorter tubes listed in the Tables in the SW 32 Ti and SW 32.1 T rotors without reduction in *g* force.
 - For detailed information on the *g*-Max system see publication DS-709.

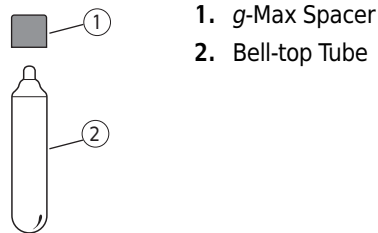

- 3 Refer to *Rotors and Tubes* for detailed information on the use and care of Quick-Seal tubes.
- Quick-Seal tubes are disposable and should be discarded after a single use.

konical Tubes

Polypropylene konical tubes, used to optimize pelleting separations, have a conical tip that concentrates the pellet in the narrow end of the tube. The narrow bottom also reduces the tube's nominal volume and minimizes gradient material requirement. The konical tubes come in both open-top and Quick-Seal tube designs. Conical cavity adapters hold the tubes in the rotor buckets

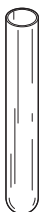
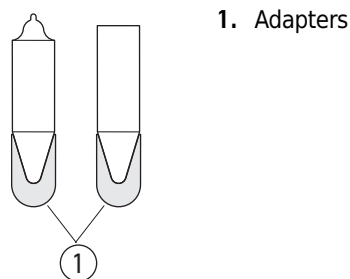

Polypropylene and Ultra-Clear Open-Top Tubes

Polypropylene and Ultra-Clear open-top tubes should be filled as full as possible (2 or 3 mm from the tube top) for tube support. If necessary, float mineral oil (or some other low-density, immiscible liquid) on top of the tube contents to fill the tube to its maximum volume. (Do not use an oil overlay in Ultra-Clear tubes.) All opposing tubes for a run must be filled to the same level with liquid of the same density.

Run Times

The k factor of the rotor is a measure of the rotor's pelleting efficiency. (Beckman Coulter has calculated the k factors for all of its preparative rotors at maximum rated speed and using full tubes.) The k factor is calculated from the formula

EQ 1

$$k = \frac{\ln(r_{\max}/r_{\min})}{\omega^2} \times \frac{10^{13}}{3600}$$

where ω is the angular velocity of the rotor in radians per second ($\omega = 0.105 \times \text{RPM}$), r_{\max} is the maximum radius, and r_{\min} is the minimum radius.

After substitution:

EQ 2

$$k = \frac{(2.533 \times 10^{11}) \ln(r_{\max}/r_{\min})}{\text{RPM}^2}$$

Use the k factor in the following equation to estimate the run time t (in hours) required to pellet particles of known sedimentation coefficient s (in Svedberg units, S).

EQ 3

$$t = \frac{k}{s}$$

Run times can be estimated for centrifugation at less than maximum speed by adjusting the k factor as follows:

EQ 4

$$k_{\text{adj}} = k \left(\frac{32,000}{\text{actual run speed}} \right)^2$$

Run times can also be estimated from data established in prior experiments if the k factor of the previous rotor is known. For any two rotors, a and b :

EQ 5

$$\frac{t_a}{t_b} = \frac{k_a}{k_b}$$

where the k factors have been adjusted for the actual run speed used.

Run Speeds

The centrifugal force at a given radius in a rotor is a function of speed. Comparisons of forces between different rotors are made by comparing the rotors' relative centrifugal fields (RCF). When rotational speed is selected so that identical samples are subjected to the same RCF in two different rotors, the samples are subjected to the same force. The RCF at a number of rotor speeds is provided in [Table 3](#).

Do not select rotational speeds in excess of 32,000 RPM. In addition, speeds must be reduced under the following circumstances:

1. If nonprecipitating solutions more dense than 1.2 g/mL are centrifuged, reduce the maximum allowable run speed according to the following equation:

EQ 6

$$\text{reduced maximum speed} = 32,000 \text{ RPM} \sqrt{\frac{1.2 \text{ g/mL}}{\rho}}$$

where ρ is the density of the tube contents. This speed reduction will protect the rotor from excessive stresses due to the added tube load.

2. *Further speed limits must be imposed* when CsCl or other self-forming-gradient salts are centrifuged, as equation (6) does not predict concentration limits/speeds that are required to prevent precipitation of salt crystals. Solid CsCl has a density of 4 g/mL, and if precipitated during centrifugation may cause rotor failure. [Figure 2](#) through [Figure 5](#), together with the description and examples below, show how to reduce run speeds when using CsCl gradients.

Table 3 Relative Centrifugal Fields for the SW 32 Ti and SW 32.1 Ti Rotors^a

Rotor Speed (RPM)	Relative Centrifugal Field ($\times g$)		
	At r_{max} (152.5 mm)	At r_{av} (109.7 mm)	At r_{min} (66.8 mm)
32,000	175,000	126,000	76,600
30,000	154,000	111,000	67,300
25,000	107,000	76,800	46,800
20,000	68,300	49,200	29,900
15,000	38,400	27,600	16,800
10,000	17,100	12,300	7,480
5,000	4,270	3,070	1,870
500	43	31	19

Rotor Speed (RPM)	Relative Centrifugal Field ($\times g$)		
	At r_{max} (162.8 mm)	At r_{av} (113.6 mm)	At r_{min} (64.4 mm)
32,000	187,000	130,000	73,900
30,000	164,000	115,000	65,000
25,000	114,000	80,000	45,100
20,000	73,000	50,900	28,900
15,000	41,000	28,600	16,200
10,000	18,200	12,700	7,210
5,000	4,560	3,180	1,800
500	46	32	18

a. Entries in this table are calculated from the formula $RCF = 1.12r (RPM/1000)^2$ and then rounded to three significant digits.

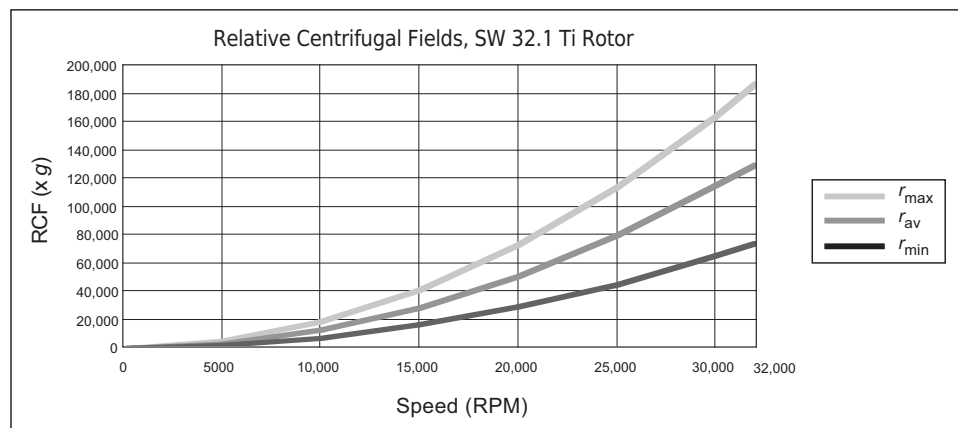
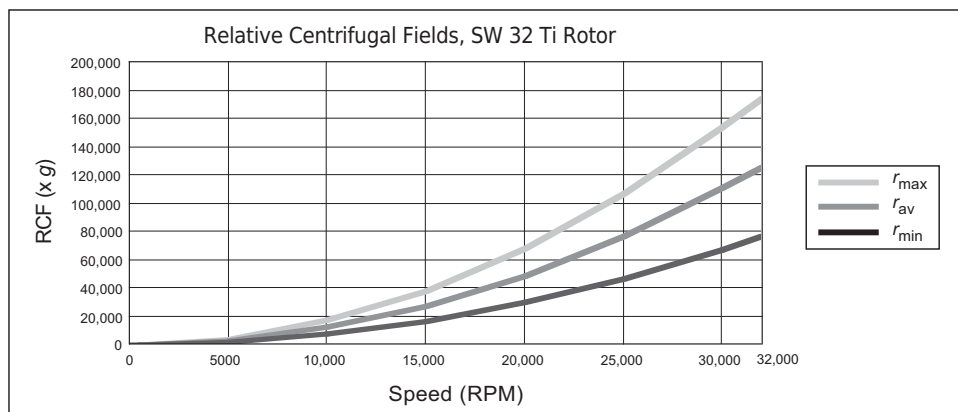
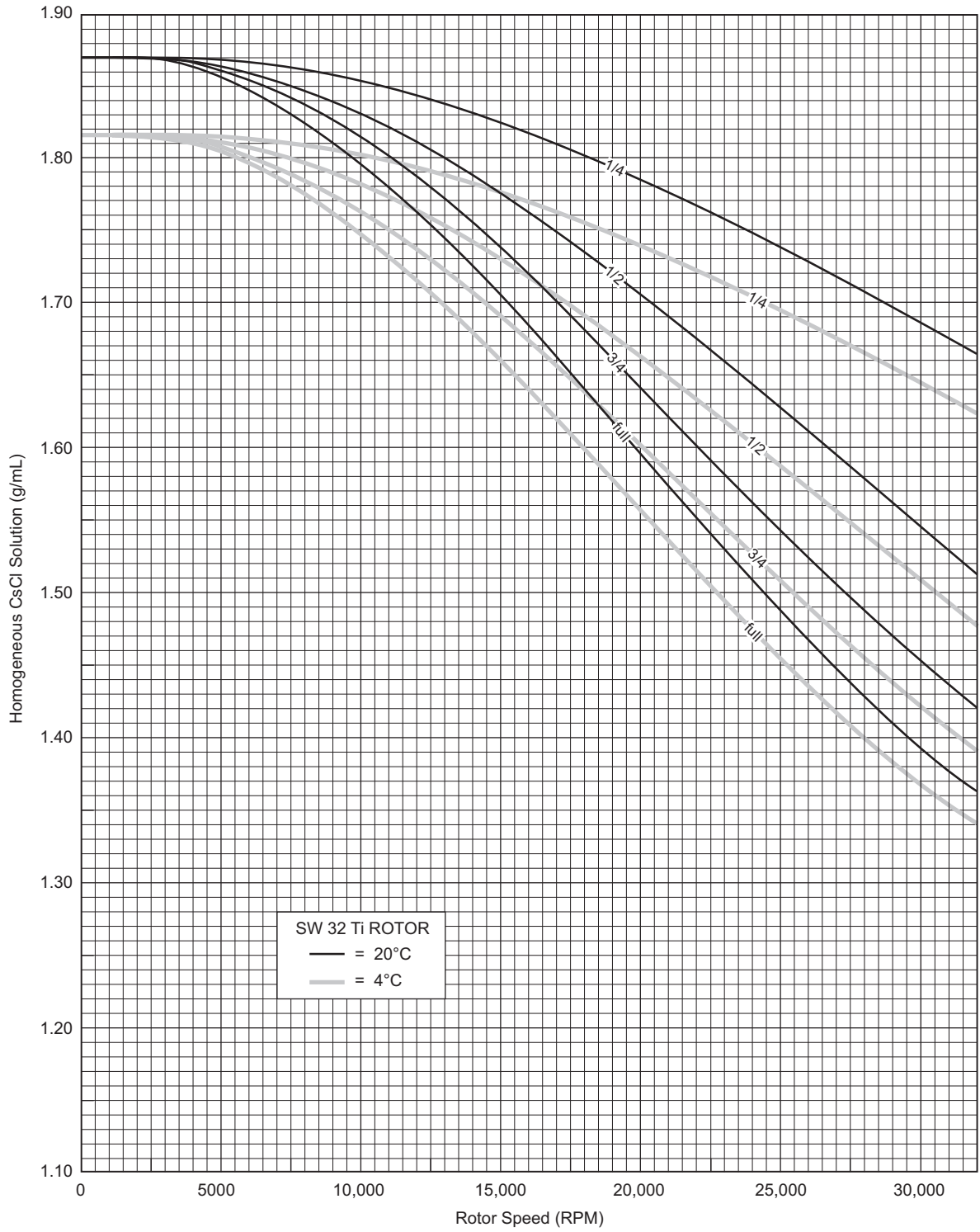
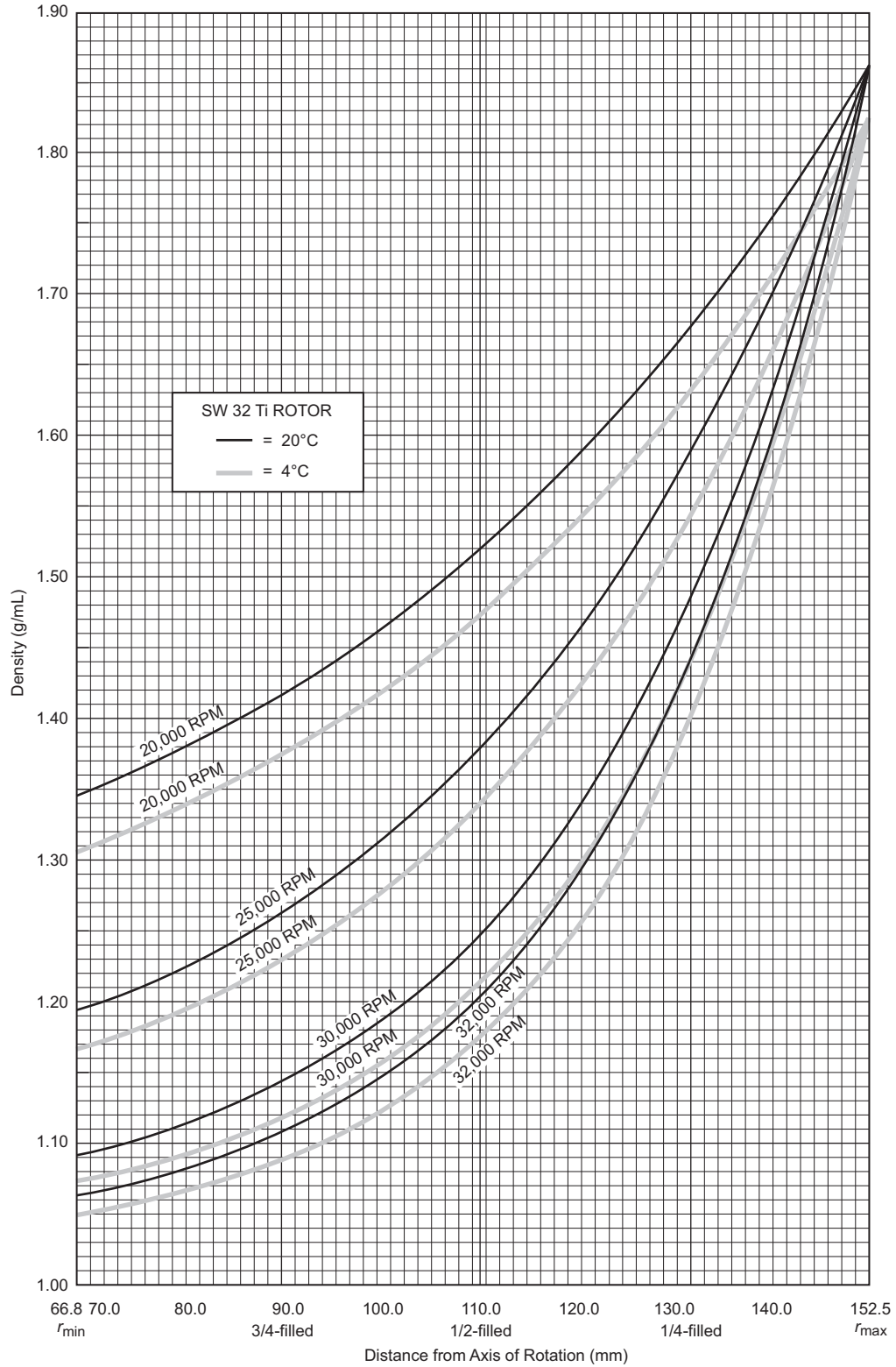

Figure 2 Precipitation Curves for the SW 32 Ti Rotor.*



* Using speed and density combinations that intersect on or below the solid curves ensures that CsCl will not precipitate during centrifugation. Tube fill volumes are indicated on the curves.

Figure 3 CsCl Gradients at Equilibrium for the SW 32 Ti Rotor*



* Centrifugation of homogeneous CsCl solutions at maximum allowable speeds (from Figure 2) results in gradients presented here.

Figure 4 Precipitation Curves for the SW 32.1 Ti Rotor*

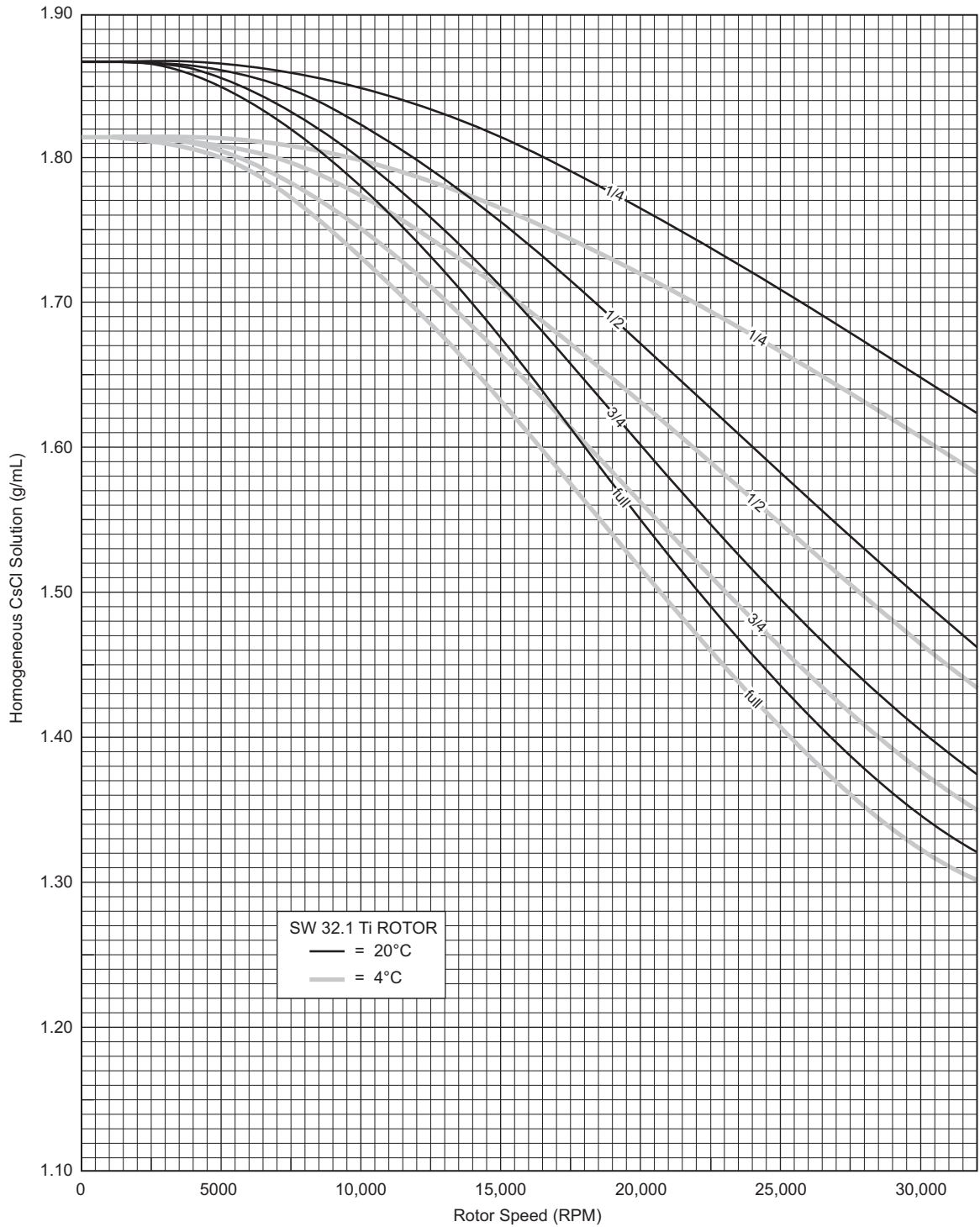

* Using speed and density combinations that intersect on or below the solid curves ensures that CsCl will not precipitate during centrifugation. Tube fill volumes are indicated on the curves.

Figure 5 CsCl Gradients at Equilibrium for the SW 32.1 Ti *

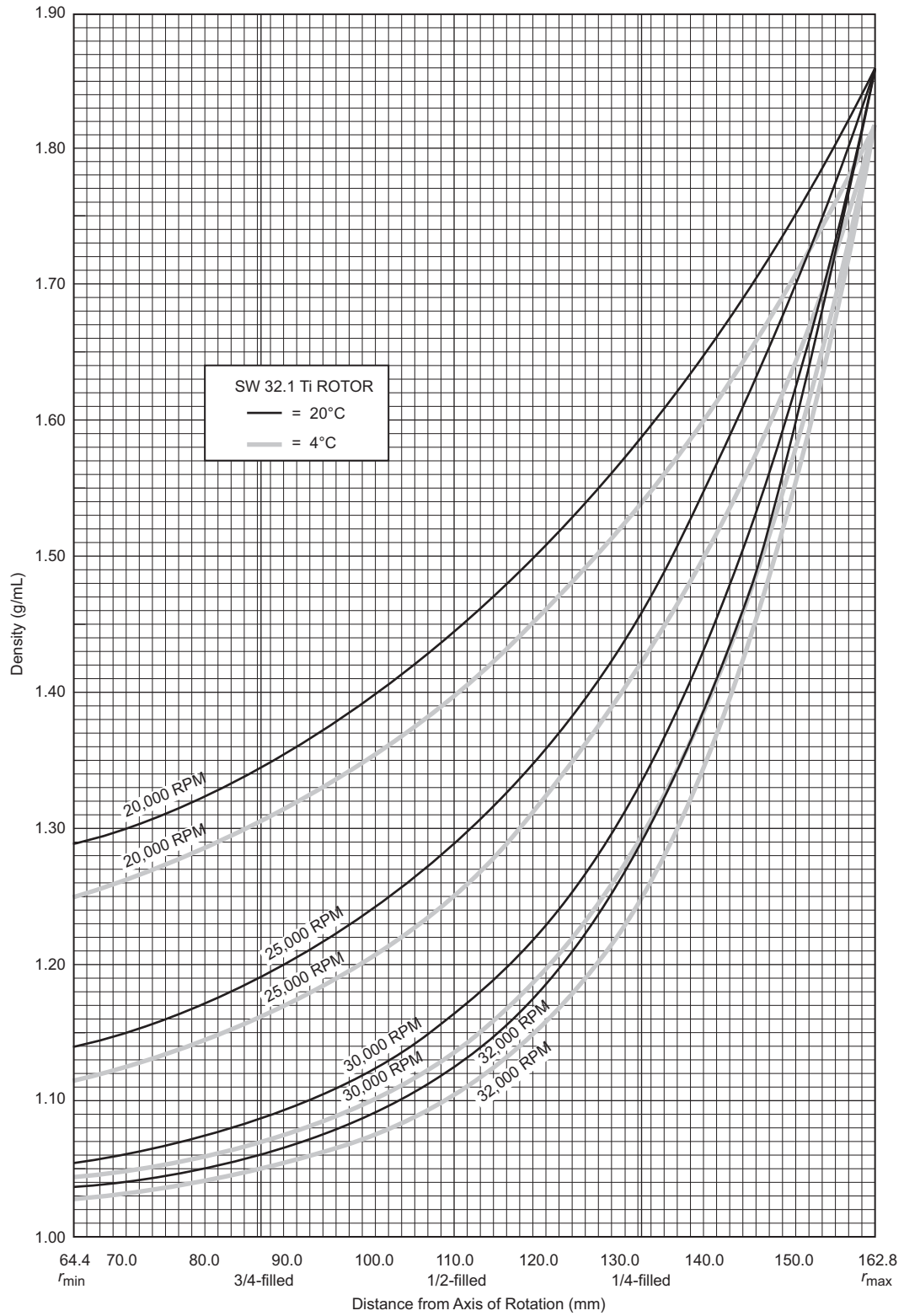

* Centrifugation of homogeneous CsCl solutions at maximum allowable speeds (from Figure 4) results in gradients presented here.

Selecting CsCl Gradients



Rotor speed is used to control the slope of a CsCl density gradient, and must be limited to prevent CsCl precipitation during centrifugation. Speed and density combinations that intersect on or below the curves in [Figure 2](#) (for the SW 32 Ti rotor) and in [Figure 4](#) (for the SW 32.1 Ti rotor) ensure that CsCl will not precipitate during centrifugation in these rotors. Curves are provided at two temperatures: 20°C (black curves) and 4°C (gray curves). Curves in [Figure 2](#) through [Figure 5](#) are provided up to the maximum speed of the rotor.

NOTE The curves in [Figure 2](#) through [Figure 5](#) are for solutions of CsCl salt dissolved in distilled water only. If other salts are present in significant concentrations, the overall CsCl concentration may need to be reduced.

The reference curves shown in [Figure 3](#) and [Figure 5](#) show gradient distribution at equilibrium. Each curve in [Figure 3](#) is within the density limits allowed for the SW 32 Ti rotor; each curve in [Figure 5](#) is within the density limits allowed for the SW 32.1 Ti rotor. Each curve was generated for a single run speed using the maximum allowable homogeneous CsCl densities (one for each fill level) that avoid precipitation at that speed. (The gradients in [Figure 3](#) and [Figure 5](#) can be generated from step or linear gradients, or from homogeneous solutions. But the total amount of CsCl in solution must be equivalent to a homogeneous solution corresponding to the concentrations specified in [Figure 3](#) and [Figure 5](#).) [Figure 3](#) and [Figure 5](#) can also be used to approximate the banding positions of sample particles. Curves not shown may be interpolated.

Adjusting Fill Volumes

[Figure 2](#) through [Figure 5](#) show that several fill volumes are possible in a tube. If a thinwall tube is partially filled with gradient solution, float mineral oil (or some other low-density, immiscible liquid) on top of the tube contents to fill the tube to its maximum volume. (Do not use an oil overlay in Ultra-Clear tubes.) Note that for a given CsCl density, as the fill level decreases the maximum allowable speed increases. Partial filling may be desirable when there is little sample or when you wish to shorten the run time

For example, in the SW 32 Ti rotor, a *quarter-filled* tube of 1.69-g/mL homogeneous CsCl solution at 4°C may be centrifuged at 25,000 RPM (see [Figure 2](#)). The segment of the 25,000 RPM curve ([Figure 3](#)) from the quarter-filled line to r_{max} (the tube bottom) represents this gradient. The same solution in a *half-filled* tube may be centrifuged no faster than 17,000 RPM, and 15,000 RPM in a *three-quarter-filled* tube. A tube *full* of the 1.69-g/mL CsCl solution may be centrifuged no faster than 13,500 RPM. Curves not shown in the figures may be interpolated

Typical Examples for Determining CsCl Run Parameters

Example A:

Starting with a homogeneous CsCl solution density of 1.40 g/mL and approximate particle buoyant densities of 1.38 and 1.42 g/mL, at 20°C, where will particles band at equilibrium in the SW 32 Ti rotor?

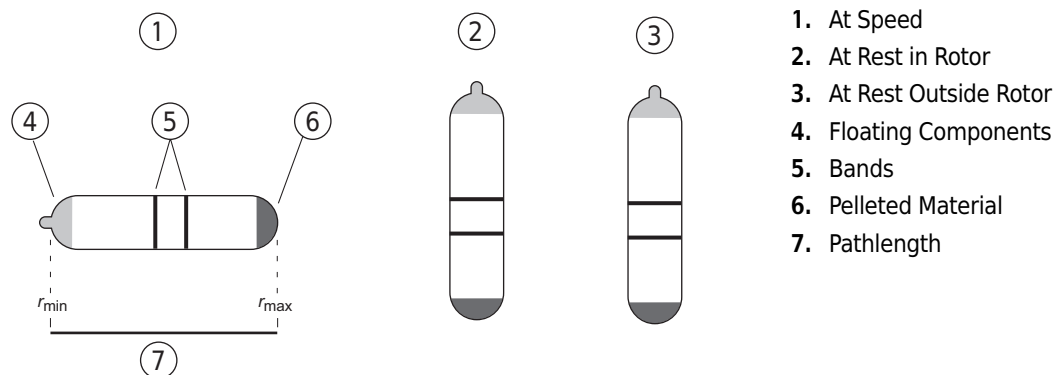

1 In [Figure 2](#), find the curve that corresponds to the required run temperature (20°C) and fill volume (three-quarters full).

- The maximum allowable rotor speed is determined from the point where this curve intersects the homogeneous CsCl density (28,000 RPM).

2 In [Figure 3](#), sketch a horizontal line corresponding to each particle's buoyant density.

3 Mark the point in [Figure 3](#) where each particle density intersects the curve corresponding to the selected run speed and temperature.

- Particles will band at these locations across the tube diameter at equilibrium during centrifugation.

In this example, particles will band about 120 and 125 mm from the axis of rotation, about 5 mm of centerband-to-centerband separation.

To determine interband volume in milliliters, use the following equation:

$$V = \pi r^2 h$$

where r is the tube radius in centimeters and h is the interband separation in centimeters

Example B:

Knowing particle buoyant densities (for example, 1.55 and 1.50 g/mL), how do you achieve good separation in the SW 32.1 Ti rotor?

-
- 1 In [Figure 5](#), sketch in a horizontal line corresponding to each particle's buoyant density.

 - 2 Select the curve at the desired temperature (20°C) and tube volume (full) that gives the best particle separation.

 - 3 Note the run speed along the selected curve (20,000 RPM).

 - 4 From [Figure 2](#), select the maximum homogeneous CsCl density (in this case, 1.56 g/mL) that corresponds to the temperature and run speed established above.
 - These parameters will provide the particle-banding pattern selected in Step 2.
-

In this example, particles will band about 119.5 and 129 mm from the axis of rotation (about 9.5 mm apart).

Care and Maintenance

Maintenance

NOTE Do not use sharp tools on the rotor that could cause scratches in the rotor surface. Corrosion begins in scratches and may open fissures in the rotor with continued use.

-
- 1 Frequently check the bucket O-rings for signs of wear.
 - a. Replace O-rings every 6 months, or whenever worn or damaged.
 - b. Use the hooked removal tool (978354) to remove O-rings.
 - c. Keep the O-rings lightly coated with silicone vacuum grease (335148).

- 2 Regularly inspect the rotor body, buckets, and caps for cracks, pitting, or heavy discoloration.

NOTE Wear will become visible over time on the contact areas between buckets and rotor body. Such wear will not affect rotor operation.

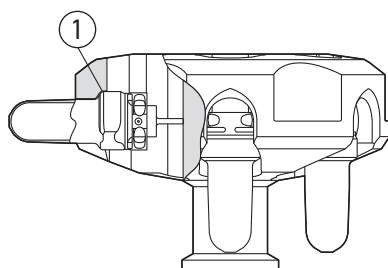

1. Contact Area

- 3 Frequently lubricate the bucket and cap mating surfaces with a thin, even coat of Spinkote lubricant (306812).

- 4 Refer to Appendix A in *Rotors and Tubes* for the chemical resistances of rotor and accessory materials.
 - Your Beckman Coulter representative provides contact with the Field Rotor Inspection Program and the rotor repair center.

Cleaning

Wash the rotor and rotor components immediately if salts or other corrosive materials are used or if spillage has occurred. Do not allow corrosive materials to dry on the rotor.

Under normal use, wash the rotor frequently (at least weekly) to prevent buildup of residues.



- 1 Wash the rotor buckets, O-rings, and caps in a mild detergent, such as Beckman Solution 555, that won't damage the rotor.
 - a. Dilute the detergent 10 to 1 with water.
 - The Rotor Cleaning Kit contains two plastic-coated brushes and two quarts of Solution 555 (339555) for use with rotors and accessories.
- 2 Rinse the cleaned rotor and components with distilled water.
- 3 Air-dry the rotor and buckets upside down. Do not use acetone to dry the rotor.

-
- 4 Air-dry the rotor and lid upside down.
 - a. Do not use acetone to dry the rotor.
-
- 5 Clean metal threads frequently to prevent buildup of residues and ensure adequate closure.
 - a. Use a brush and concentrated Solution 555.
 - b. Rinse and dry thoroughly, then lubricate lightly but evenly with Spinkote to coat all threads.
-

Decontamination



If the rotor or other components are contaminated with toxic, radioactive, or pathogenic materials, follow appropriate decontamination procedures as outlined by your laboratory safety officer. Refer to Appendix A in *Rotors and Tubes* to select solutions that will not damage the rotor and accessory materials.

Sterilization and Disinfection

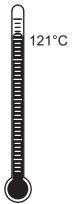

- The rotor and all rotor components, except those made of Noryl, can be autoclaved at 121°C for up to an hour. Remove the plugs from the rotor and place the rotor, plugs, and spacers in the autoclave upside down.
- Ethanol (70%)* or hydrogen peroxide (6%) may be used on all rotor components, including those made of plastic. Bleach (sodium hypochlorite) may be used, but may cause discoloration of anodized surfaces. Use the minimum immersion time for each solution, per laboratory standards.

While Beckman Coulter has tested these methods and found that they do not damage the rotor or components, no guarantee of sterility or disinfection is expressed or implied. When sterilization or disinfection is a concern, consult your laboratory safety officer regarding proper methods to use.

Refer to publication IN-192 (included with each box of tubes) for tube sterilization and disinfection procedures. *Quick-Seal, Ultra Clear, and thinwall open-top tubes are disposable and should be discarded after a single use.*

Storage

When it is not in use, store the rotor and buckets in a dry environment (not in the instrument). Remove the bucket caps to allow air circulation so that moisture will not collect in the buckets.

* Flammability hazard. Do not use in or near operating ultracentrifuges.

Returning a Rotor

Before returning a rotor or accessory for any reason, prior permission must be obtained from Beckman Coulter, Inc. This form may be obtained from your local Beckman Coulter sales office. The form, entitled *Returned Material Authorization (RMA)* for United States returns or *Returned Goods Authorization (RGA)* for international returns, should contain the following information:

- rotor type and serial number,
- history of use (approximate frequency of use),
- reason for the return,
- original purchase order number, billing number, and shipping number, if possible,
- name and email address of the person to be notified upon receipt of the rotor or accessory at the factory,
- name and email address of the person to be notified about repair costs, etc.

To protect our personnel, it is the customer's responsibility to ensure that all parts are free from pathogens and/or radioactivity. Sterilization and decontamination must be done before returning the parts. Smaller items (such as tubes, bottles, etc.) should be enclosed in a sealed plastic bag.

*All parts must be accompanied by a note, plainly visible on the outside of the box or bag, stating that they are safe to handle and that they are not contaminated with pathogens or radioactivity. **Failure to attach this notification will result in return or disposal of the items without review of the reported problem.***

Use the address label printed on the RMA/RGA form when mailing the rotor and/or accessories.

Customers located outside the United States should contact their local Beckman Coulter office.

Supply List

NOTE Publications referenced in this manual can be obtained at www.beckmancoulter.com, by calling Beckman Coulter at 1-800-742-2345 in the United States, or by contacting your local Beckman Coulter office.

See the Beckman Coulter *Ultracentrifuge Rotors, Tubes & Accessories* catalog (BR-8101, available at www.beckmancoulter.com) or contact Beckman Coulter Sales (1-800-742-2345 in the United States) for detailed information on ordering parts and supplies. For your convenience, a partial list is given below.

Replacement Rotor Parts

Description	Part Number
SW 32 Ti rotor assembly	369650
SW 32 Ti buckets (set of 6, black, with caps and O-rings)	369647
SW 32 Ti bucket O-ring	812715

Description	Part Number
SW 32 Ti cap (black)	369643
SW 32.1 Ti rotor assembly	369651
SW 32.1 Ti buckets (set of 6, red, with caps and O-rings)	369648
SW 32.1 Ti bucket O-ring	812715
SW 32.1 Ti cap (red)	369645
Rotor stand	332400
Overspeed disk (32,000 RPM)	335456

Other

NOTE For MSDS information, go to the Beckman Coulter website at www.beckmancoulter.com.

Description	Part Number
Tubes and accessories	see Table 1 and Table 2
Bucket holder rack	331186
Quick-Seal Cordless Tube Topper kit, 60 Hz	358312
Quick-Seal Cordless Tube Topper kit, 50 Hz (Europe)	358313
Quick-Seal Cordless Tube Topper kit, 50 Hz (Great Britain)	358314
Quick-Seal Cordless Tube Topper kit, 50 Hz (Australia)	358315
Quick-Seal Cordless Tube Topper kit, 50 Hz (Canada)	367803
Tube racks for the Tube Topper for 16-mm diameter tubes	348123
for 38-mm diameter tubes	348124
OptiSeal tube rack	361646
Tube removal tool (Quick-Seal tubes)	361668
Extractor tool (konical tube adapters)	354468
Spinkote lubricant (2 oz)	306812
Silicone vacuum grease (1 oz)	335148
Rotor Cleaning Kit	339558
Beckman Solution 555 (1 qt)	339555
Rotor cleaning brush	339379
Hooked O-ring removal tool	978354

Beckman Coulter, Inc.

Ultracentrifuge Rotor Warranty

All Beckman Coulter ultracentrifuge Fixed Angle, Vertical Tube, Near Vertical Tube, Swinging Bucket, and Airfuge rotors are warranted against defects in materials or workmanship for the time periods indicated below, subject to the Warranty Conditions stated below.

Preparative Ultracentrifuge Rotors	5 years — No Proration
Analytical Ultracentrifuge Rotors	5 years — No Proration
ML and TL Series Ultracentrifuge Rotors	5 years — No Proration
Airfuge Ultracentrifuge Rotors	1 year — No Proration
For Zonal, Continuous Flow, Component Test, and Rock Core Ultracentrifuge Rotors, see separate warranty.	

1. This warranty is valid for the time periods indicated above from the date of shipment to the original Buyer by Beckman Coulter or an authorized Beckman Coulter representative.
2. This warranty extends only to the original Buyer and may not be assigned or extended to a third person without written consent of Beckman Coulter.
3. This warranty covers the Beckman Coulter Centrifuge Systems only (including but not limited to the centrifuge, rotor, and accessories) and Beckman Coulter shall not be liable for damage to or loss of the user's sample, non-Beckman Coulter tubes, adapters, or other rotor contents.
4. This warranty is void if the Beckman Coulter Centrifuge System is determined by Beckman Coulter to have been operated or maintained in a manner contrary to the instructions in the operator's manual(s) for the Beckman Coulter Centrifuge System components in use. This includes but is not limited to operator misuse, abuse, or negligence regarding indicated maintenance procedures, centrifuge and rotor classification requirements, proper speed reduction for the high density of certain fluids, tubes, and tube caps, speed reduction for precipitating gradient materials, and speed reduction for high-temperature operation.
5. Rotor bucket sets purchased concurrently with or subsequent to the purchase of a Swinging Bucket Rotor are warranted only for a term co-extensive with that of the rotor for which the bucket sets are purchased.
6. This warranty does not cover the failure of a Beckman Coulter rotor in a centrifuge not of Beckman Coulter manufacture, or if the rotor is used in a Beckman Coulter centrifuge that has been modified without the written permission of Beckman Coulter, or is used with carriers, buckets, belts, or other devices not of Beckman Coulter manufacture.
7. Rotor parts subject to wear, including but not limited to rotor O-rings, VTi, NVT, TLV, MLN, and TLN rotor tube cavity plugs and gaskets, tubing, tools, optical overspeed disks, bearings, seals, and lubrication are excluded from this warranty and should be frequently inspected and replaced if they become worn or damaged.
8. Keeping a rotor log is not mandatory, but may be desirable for maintenance of good laboratory practices.

Repair and Replacement Policies

1. If a Beckman Coulter rotor is determined by Beckman Coulter to be defective, Beckman Coulter will repair or replace it, subject to the Warranty Conditions. A replacement rotor will be warranted for the time remaining on the original rotor's warranty.
2. If a Beckman Coulter centrifuge is damaged due to a failure of a rotor covered by this warranty, Beckman Coulter will supply free of charge (i) all centrifuge parts required for repair (except the drive unit, which will be replaced at the then current price less a credit determined by the total number of revolutions or years completed, provided that such a unit was manufactured or rebuilt by Beckman Coulter), and (ii) if the centrifuge is currently covered by a Beckman Coulter warranty or Full Service Agreement, all labor necessary for repair of the centrifuge.
3. If a Beckman Coulter rotor covered by this warranty is damaged due to a malfunction of a Beckman Coulter ultracentrifuge covered by an Ultracentrifuge System Service Agreement, Beckman Coulter will repair or replace the rotor free of charge.
4. If a Beckman Coulter rotor covered by this warranty is damaged due to a failure of a Beckman Coulter tube, bottle, tube cap, spacer, or adapter, covered under the Conditions of this Warranty, Beckman Coulter will repair or replace the rotor and repair the instrument as per the conditions in policy point (2) above, and the replacement policy.
5. Damage to a Beckman Coulter rotor or instrument due to the failure or malfunction of a non-Beckman Coulter tube, bottle, tube cap, spacer, or adapter is not covered under this warranty, although Beckman Coulter will assist in seeking compensation under the manufacturer's warranty.

Disclaimer

IT IS EXPRESSLY AGREED THAT THE ABOVE WARRANTY SHALL BE IN LIEU OF ALL WARRANTIES OF FITNESS AND OF THE WARRANTY OF MERCHANTABILITY AND BECKMAN COULTER, INC. SHALL HAVE NO LIABILITY FOR SPECIAL OR CONSEQUENTIAL DAMAGES OF ANY KIND WHATSOEVER ARISING OUT OF THE MANUFACTURE, USE, SALE, HANDLING, REPAIR, MAINTENANCE, OR REPLACEMENT OF THE PRODUCT.

Factory Rotor Inspection Service

Beckman Coulter, Inc., will provide free mechanical and metallurgical inspection in Indianapolis, Indiana, USA, of any Beckman Coulter rotor at the request of the user. (Shipping charges to Beckman Coulter are the responsibility of the user.) Rotors will be inspected in the user's laboratory if the centrifuge in which they are used is covered by an appropriate Beckman Coulter Service Agreement. Contact your local Beckman Coulter office for details of service coverage or cost.

Before shipping, contact the nearest Beckman Coulter Sales and Service office and request a Returned Goods Authorization (RGA) form and packaging instructions. Please include the complete rotor assembly, with buckets, lid, handle, tube cavity caps, etc. A SIGNED STATEMENT THAT THE ROTOR AND ACCESSORIES ARE NON-RADIOACTIVE, NON-PATHOGENIC, NON-TOXIC, AND OTHERWISE SAFE TO SHIP AND HANDLE IS REQUIRED.

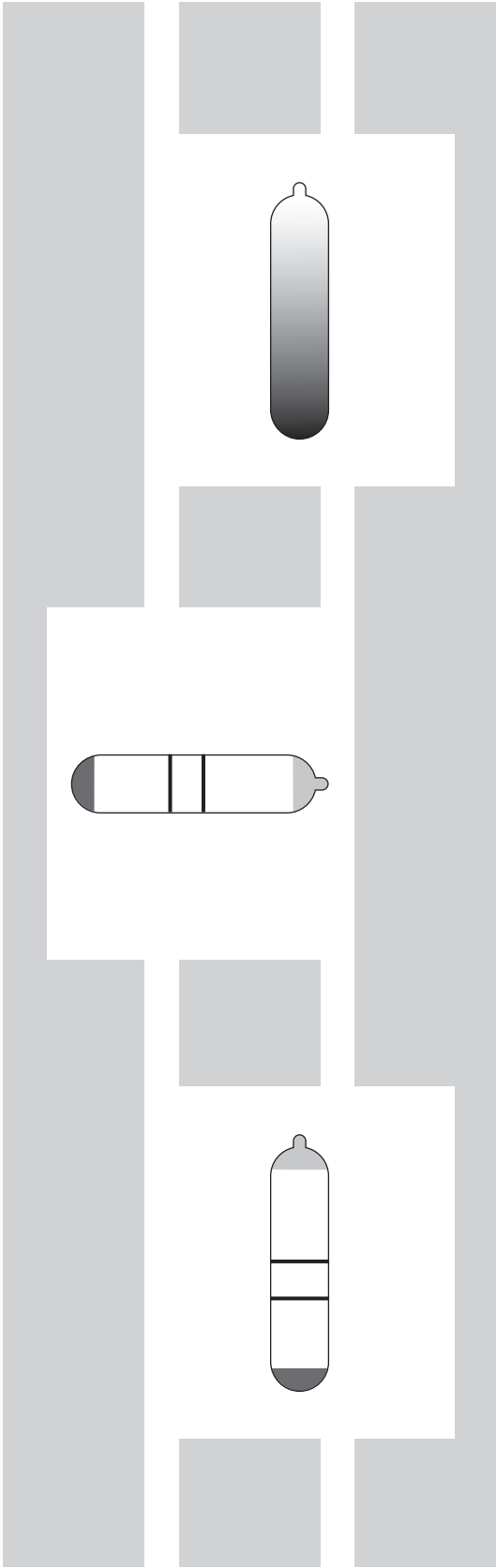

Related Documents

Rotors and Tubes for Preparative Ultracentrifuges (LR-IM)

- Rotors
- Tubes, Bottles, and Accessories
- Using Tubes, Bottles, and Accessories
- Using Fixed-Angle Rotors
- Using Swinging-Bucket Rotors
- Using Vertical-Tube and Near-Vertical Tube Rotors
- Care and Maintenance
- Chemical Resistances for Beckman Coulter Centrifugation Products
- Use of the w2t Integrator
- The Use of Cesium Chloride Curves
- Gradient Materials
- References
- Glossary

Available in electronic pdf by request.

Rotors and Tubes CD (369668)

- Rotors and Tubes for Tabletop Preparative Ultracentrifuges
- Rotors and Tubes for J2, J6, Avanti J Series Centrifuges
- Rotors and Tubes for Preparative Ultracentrifuges
- Rotor Safety Bulletin
- Chemical Resistances for Beckman Coulter Centrifugation Products

Included with shipment of instrument.

Additional References

- Chemical Resistances for Beckman Coulter Centrifugation Products (IN-175)
- Beckman Coulter Ultracentrifuge Rotors, Tubes & Accessories catalog (BR-8101)
- Using OptiSeal Tubes (IN-189)
- Use and Care of Centrifuge Tubes and Bottles (IN-192)

Available in hard copy or electronic pdf by request, also available at www.beckmancoulter.com.

Data Sheets

- *g*-Max System: Short Pathlengths in High Force Fields (DS-709B)

Available at www.beckmancoulter.com

www.beckmancoulter.com

